

WCM318 Series

Power Inductors

Product Description

WCM's 318 series inductors are designed for use in buck boost (differential) circuits. Using an improved generation of Shaped Foil Technology, this inductor series has lower core and winding losses than competing products, especially at frequencies over 10 kHz and ripple current magnitudes of 5% and higher. The 318 series is an industry leading low cost, high performance inductor.

Shaped Foil Technology™

West Coast Magnetics' exclusive shaped foil technology™ combines the low DCR of a foil winding, with the low AC winding resistance of Litz wire. For many high ripple, high frequency applications this product has significantly lower winding losses than any Litz or solid wire winding. Check with WCM's engineering department to see if it is right for your application.

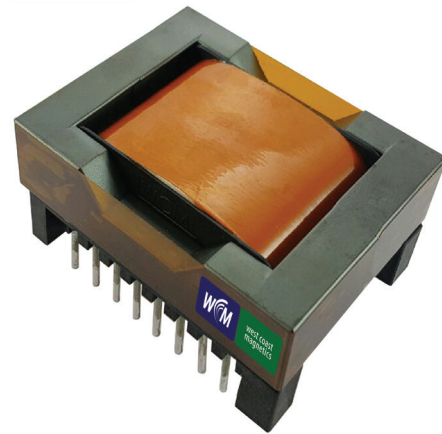

Engineering Data

Product Code	Inductance (μH) ± 10%	DCR (mΩ)	Idc INPUT (A)	Schematic
WCM318-01	112.7	28.87	6.00	A
WCM318-02	51.8	10.46	14.00	A
WCM318-03	30.5	6.13	19.00	A
WCM318-04	14.7	3.07	23.00	A
WCM318-05	11.6	2.32	25.00	A
WCM318-06	6.6	1.14	40.00	B
WCM318-07	4.6	0.74	45.00	B
WCM318-08	3.0	0.46	55.00	B



Graphs WCM318 Series

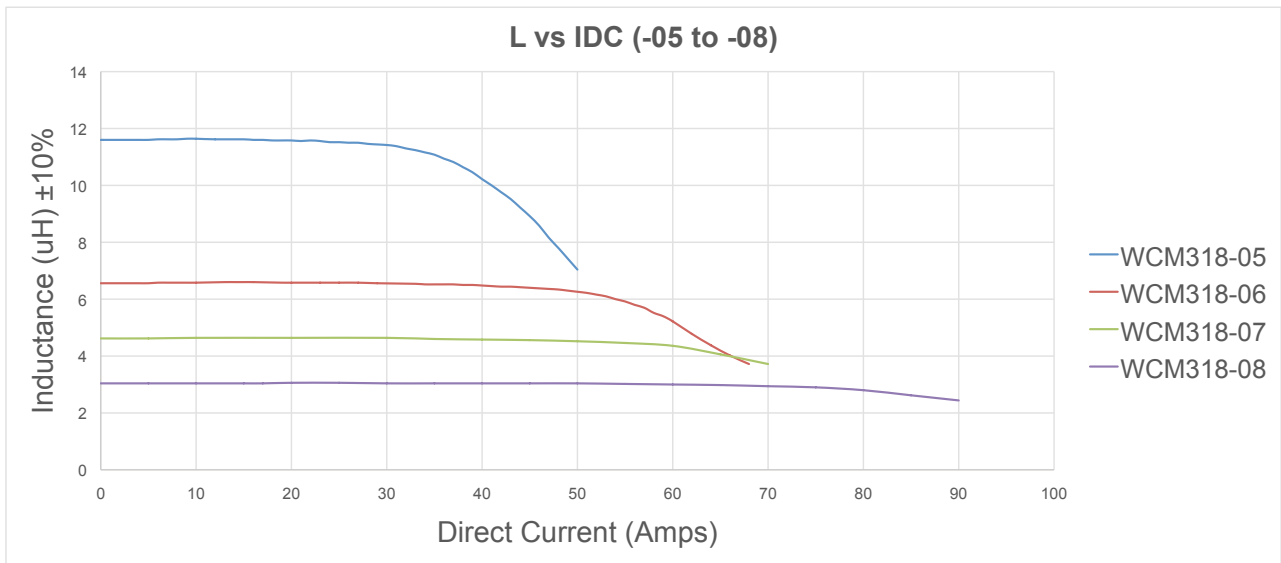
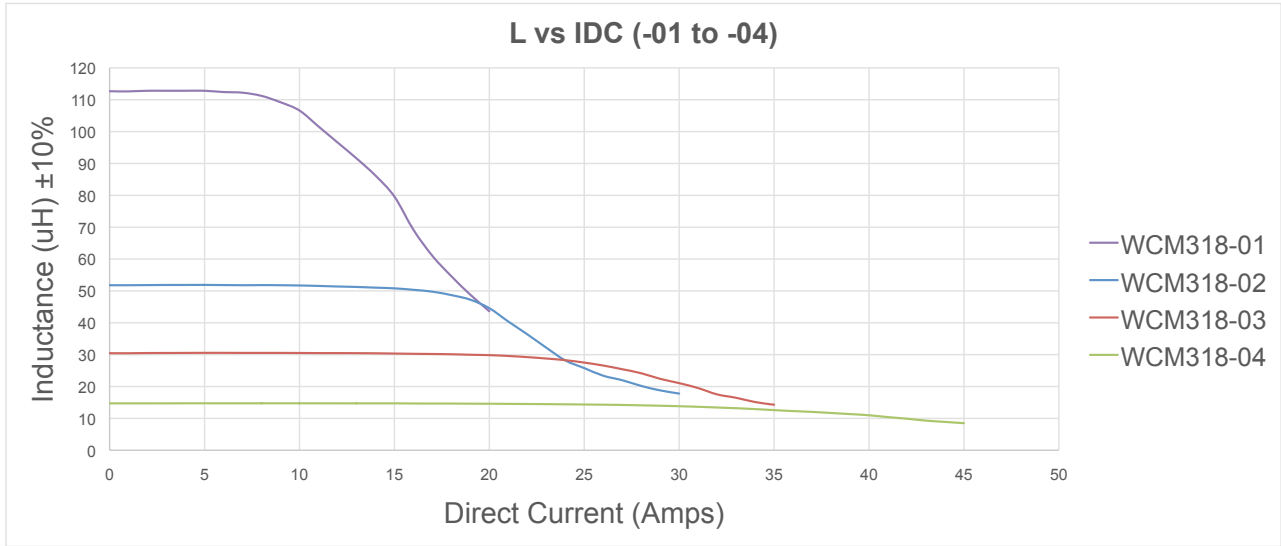

Schematics WCM318 Series

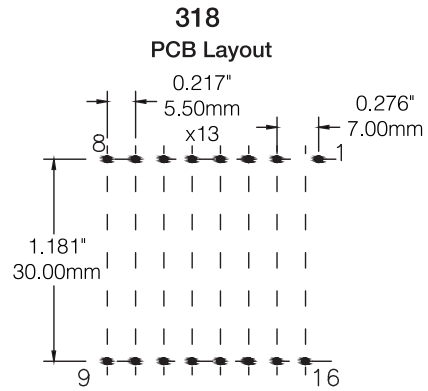
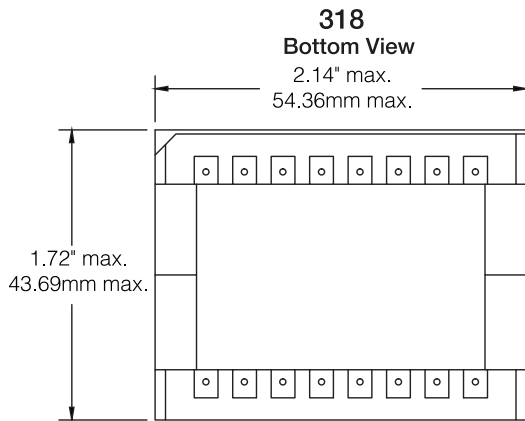
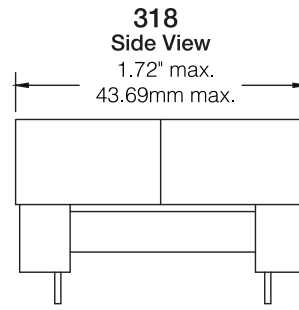
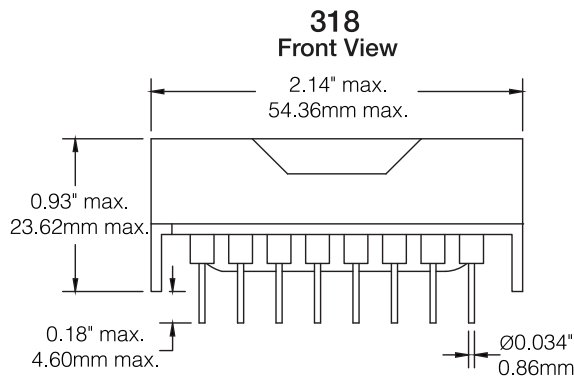

Tolerance	Inches	Millimeters
	x.xx ± 0.020"	x.x ± 0.25 mm
	x.xxx ± 0.005"	x.xx ± 0.13 mm

318 Schematic A

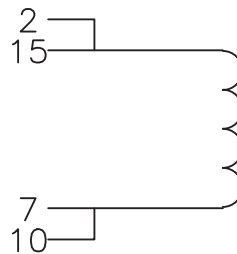

318 Schematic B

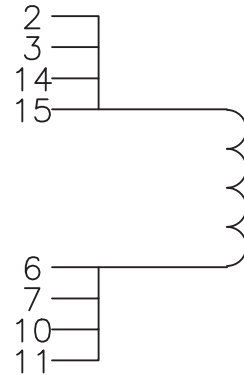

Dimensions:
 Inches
 mm

Note:
 Please specify vertical or horizontal mount with your order.