

# 505 series

## common mode chokes

### PRODUCT DESCRIPTION

West Coast Magnetics' 505 series provides very high attenuation of common mode noise for lower current level applications. This choke provides 5000 Ohms of impedance from 200 kHz to 6 MHz for low power applications. At the maximum rated RMS current level of 9amps, 100 Ohms of noise impedance are available up to 70 MHz. The 505 series package is a compact SMD carrier. This common mode choke features 1500 Vac of isolation between windings, which meets most low power safety agency standards.

### FEATURES & BENEFITS

Very high common mode noise attenuation for low power applications – Power handling to 9amps – Compact SMD package – 1500 Vac winding to winding isolation – Tape and reel available



Product Code	Nominal Inductance ( $\mu$ H)	Rated RMS Current (amps) 40°C Temp Rise	Rated RMS Current (amps) 60°C Temp Rise	Rated RMS Current (amps) 80°C Temp Rise	Typical Leakage Inductance ( $\mu$ H)	Nominal DCR ( $\Omega$ )	Hypot (Vac)
505-1	100	5.65	8.80	8.99	0.7	0.003	1500
505-2	150	5.35	7.45	8.65	1.0	0.004	1500
505-3	220	4.95	6.08	8.33	1.2	0.005	1500
505-4	330	4.45	5.50	6.45	1.4	0.009	1500
505-5	500	3.48	4.18	4.78	2.1	0.017	1500
505-6	750	2.95	3.50	4.05	2.7	0.025	1500
505-7	1000	2.50	2.78	3.14	3.7	0.045	1500
505-8	1200	2.30	2.71	3.04	4.3	0.051	1500
505-9	1800	1.90	2.19	2.50	5.3	0.073	1500
505-10	2200	1.50	1.73	1.94	7.7	0.102	1500
505-11	3300	1.05	1.28	1.44	11.0	0.191	1500
505-12	5000	0.78	0.91	1.08	15.0	0.381	1500
505-13	7500	0.53	0.63	0.72	26.0	0.723	1500
505-14	10000	0.43	0.55	0.60	33.0	1.038	1500

Common Mode Noise Impedance  
WCM505-01,-02,-03

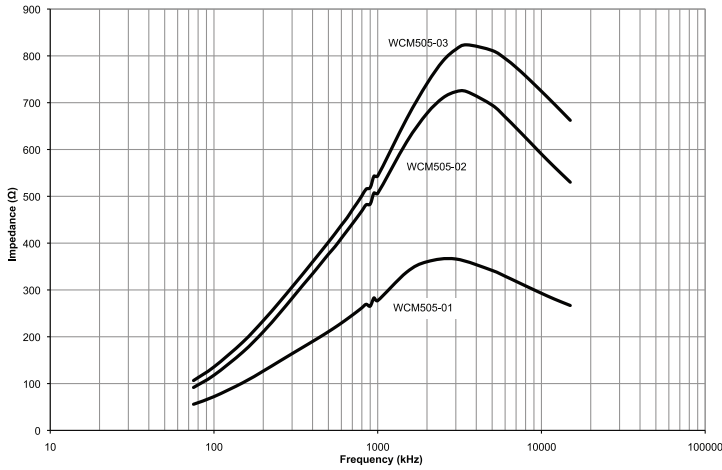

Common Mode Noise Impedance  
WCM505-04,-05,-06,-07

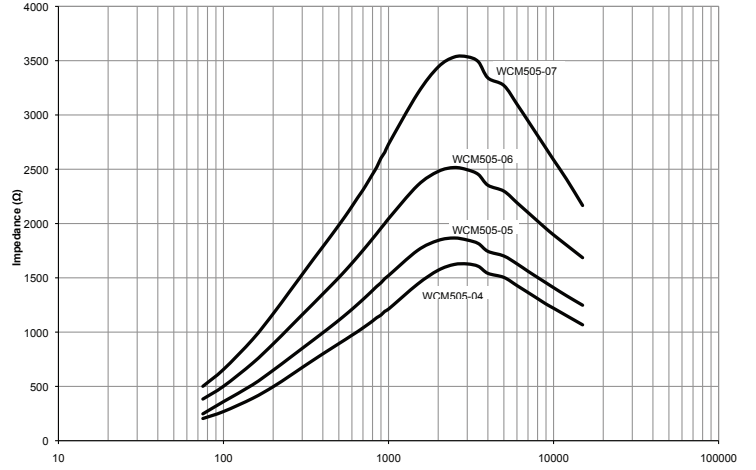

Common Mode Noise Impedance  
WCM-08,-09,-10

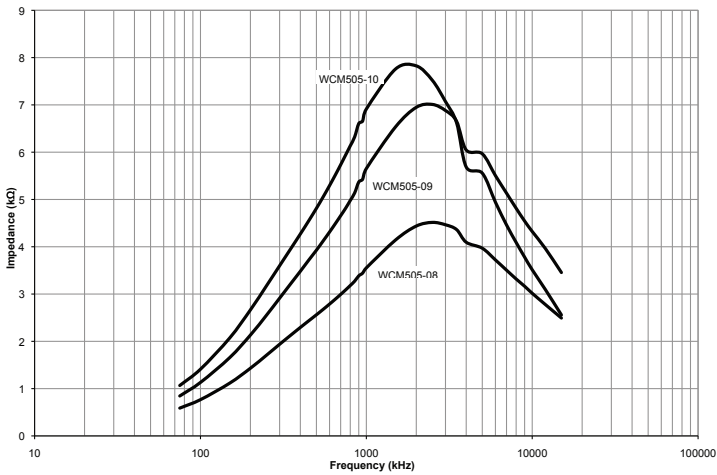

Common Mode Noise Impedance  
WCM-11,-12,-13,-14

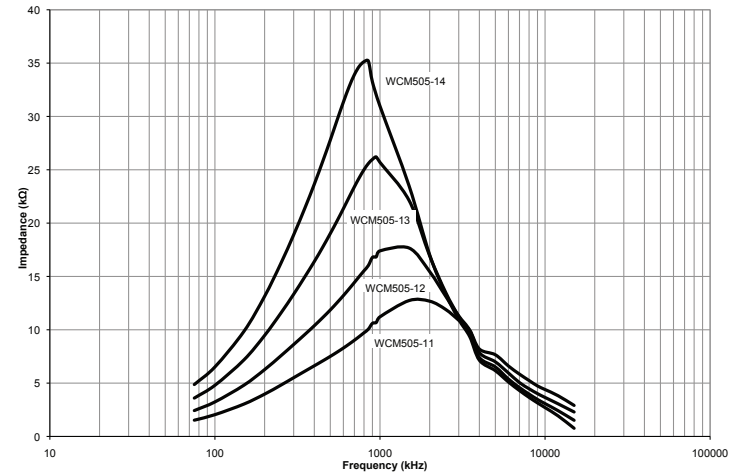

Dimensions:  $\frac{\text{Inches}}{\text{cm}}$

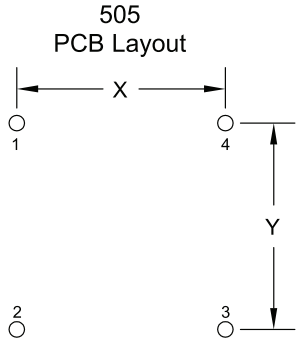
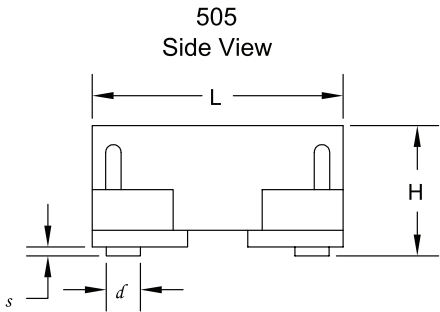
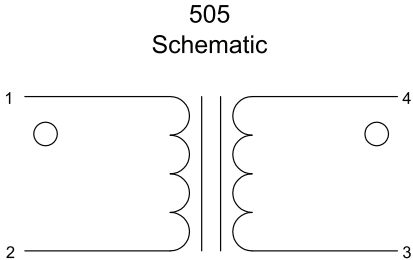
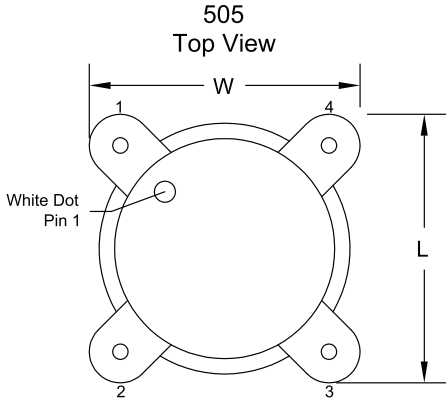

Product Code	L	W	H	s	d	X	Y
505	$\frac{0.530}{13.5}$	$\frac{0.530}{13.5}$	$\frac{0.290}{7.4}$	$\frac{0.030}{0.8}$	$\frac{0.060}{1.5}$	$\frac{0.400}{10.2}$	$\frac{0.400}{10.2}$