



310 series

power inductors

PRODUCT DESCRIPTION

WCM's 310 series inductors are designed for use in buck boost (differential) circuits. Using an improved generation of Shaped Foil Technology, this inductor series has lower core and winding losses than competing products, especially at frequencies over 10 kHz and ripple current magnitudes of 5% and higher. The 310 series is an industry leading low cost, high performance inductor.

SHAPED FOIL TECHNOLOGY™

West Coast Magnetics' exclusive SHAPED FOIL TECHNOLOGY™ combines the low DCR of a foil winding, with the low AC winding resistance of litz wire. For many high ripple, high frequency applications it has significantly lower winding losses than any litz or solid wire winding. Check with WCM's engineering department to see if it is right for your application.

Product Code	Inductance (μH)	DCR ($m\Omega$)	idc amps INPUT	Schematic
310-01	380.8	44.90	7.00	A
310-02	169.0	16.95	12.00	A
310-03	141.6	13.70	13.00	A
310-04	116.4	10.58	15.00	A
310-05	83.5	7.20	18.00	A
310-06	49.7	4.40	22.00	A
310-07	41.5	3.83	24.00	A
310-08	36.1	3.25	26.00	A
310-09	29.3	2.83	28.00	A
310-10	23.6	2.30	32.00	B
310-11	18.6	1.90	37.00	B
310-12	14.4	1.53	41.00	B
310-13	10.4	1.28	45.00	B
310-14	7.3	1.13	55.00	B

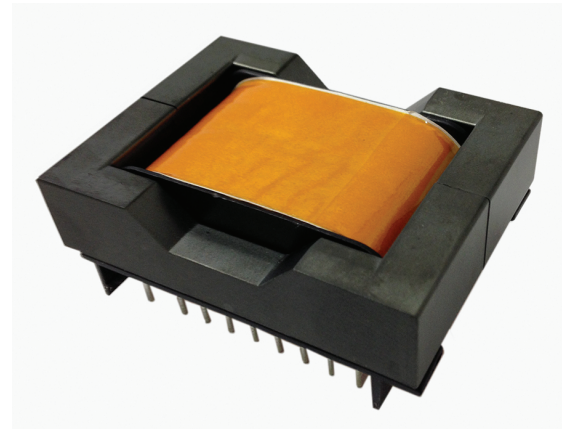



west coast
magnetics

310 series *page 2*

power inductors

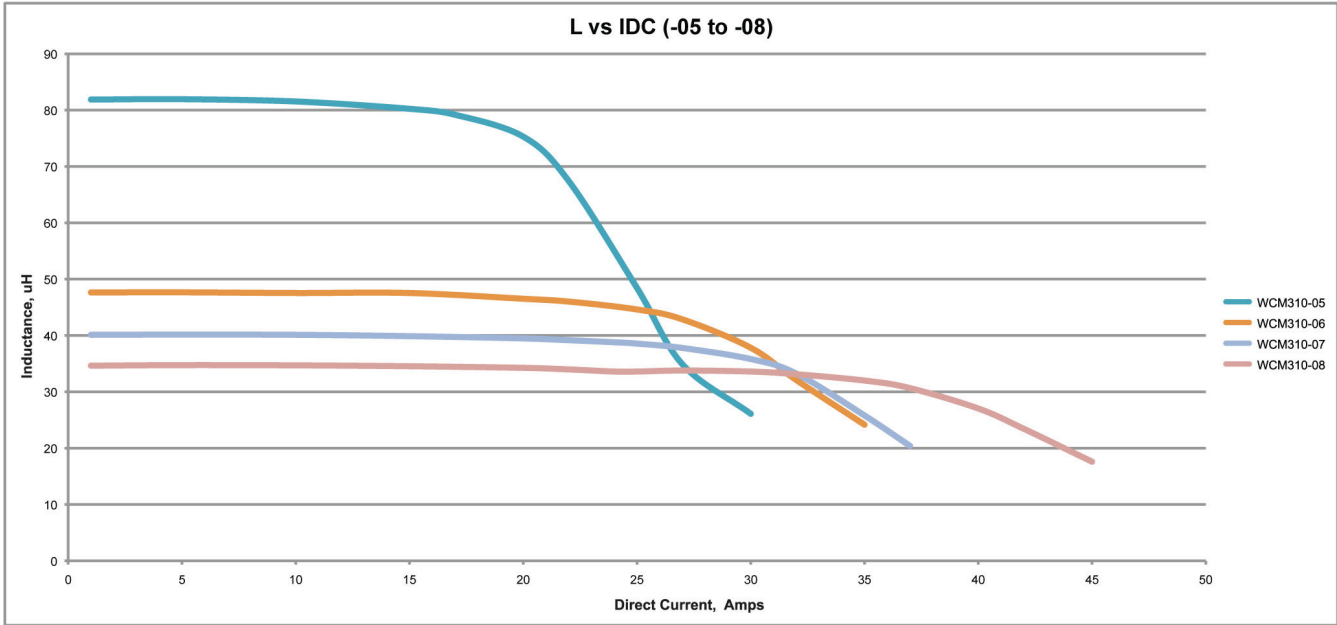
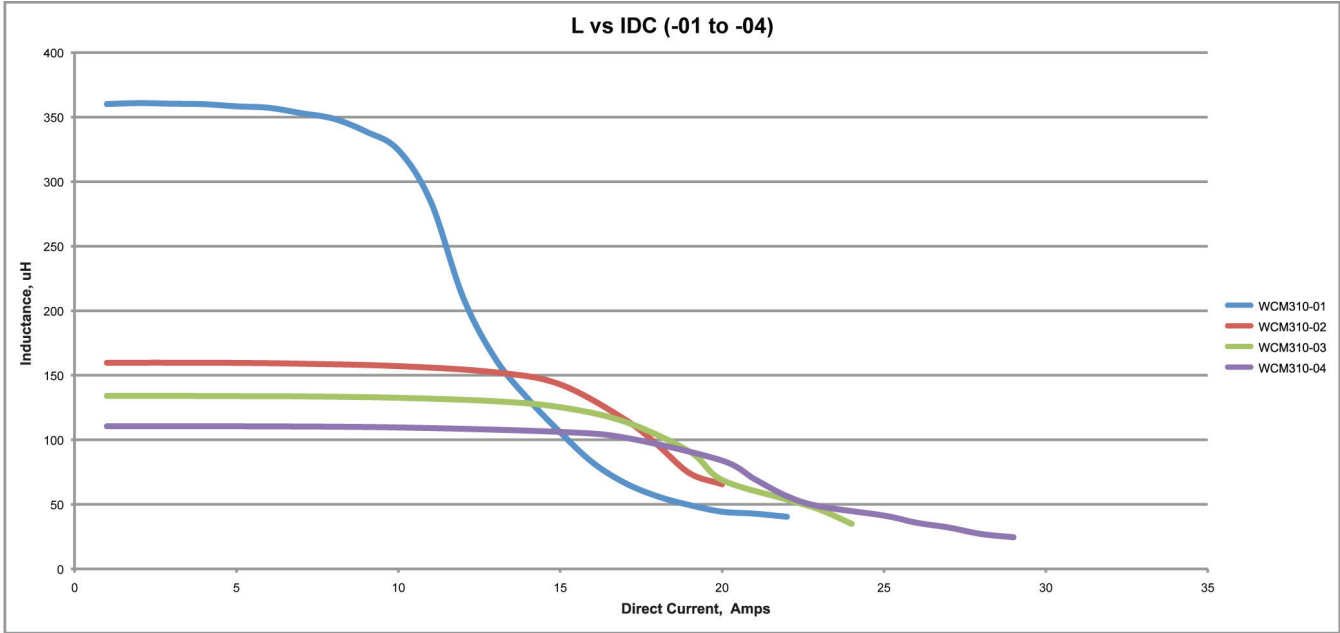



power inductors

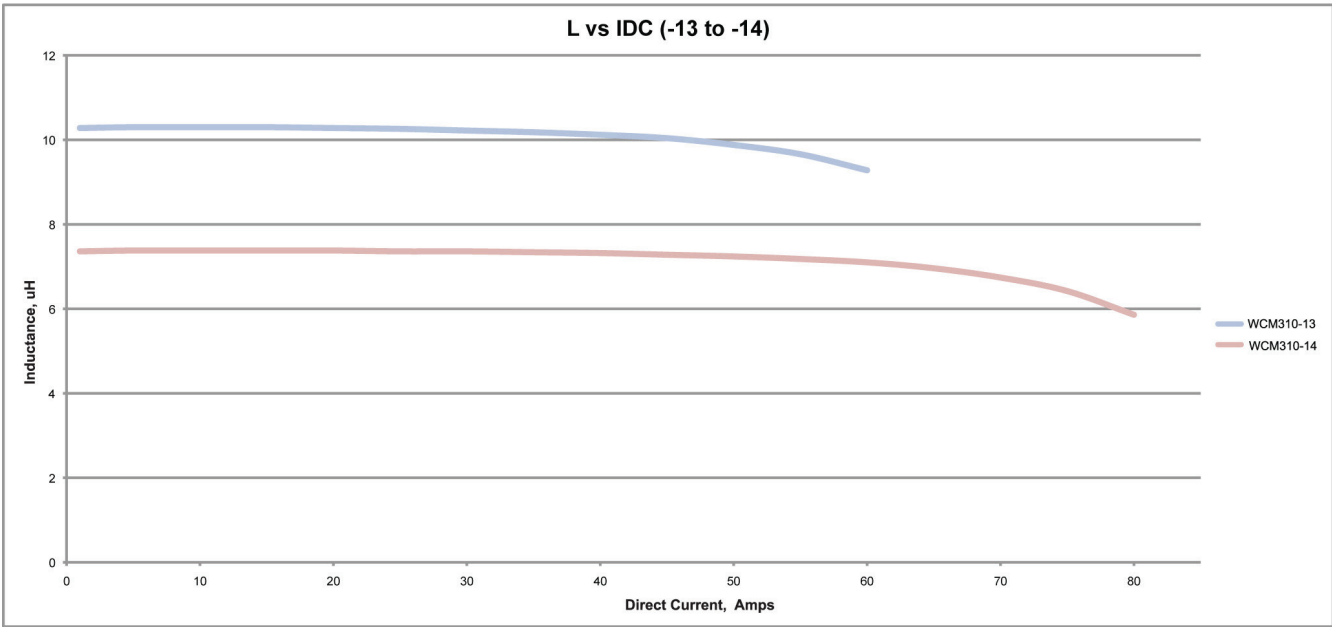
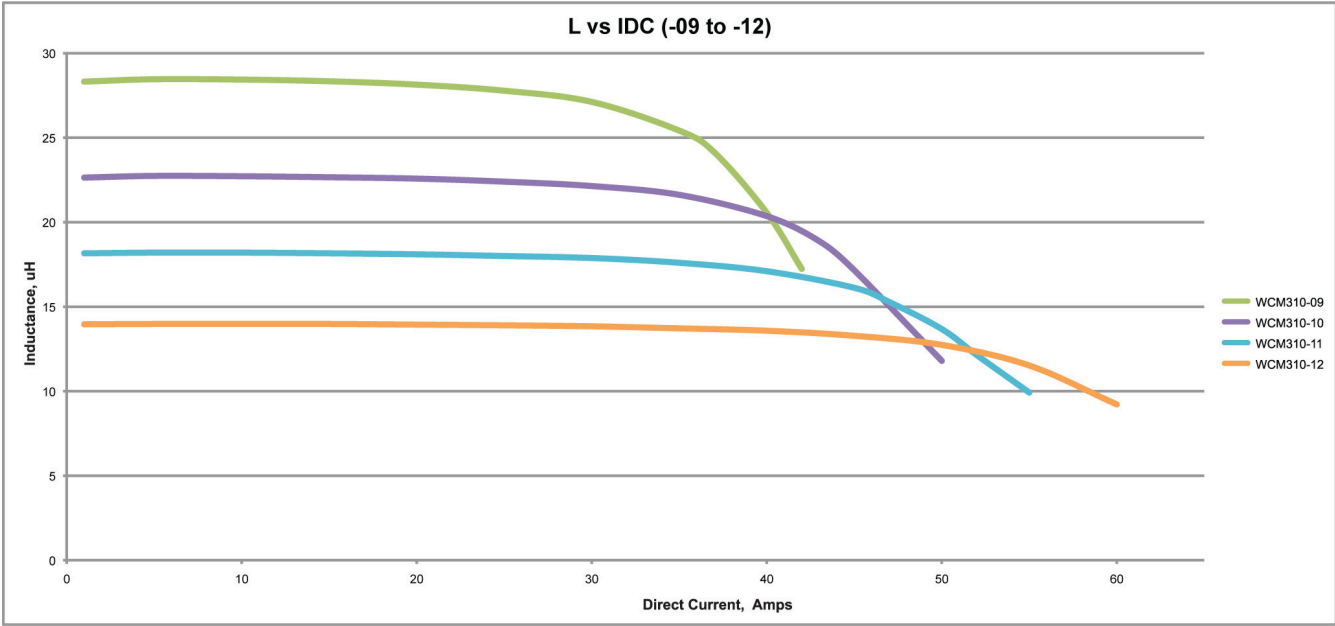



power inductors

Dimensions: $\frac{\text{inches}}{\text{mm}}$

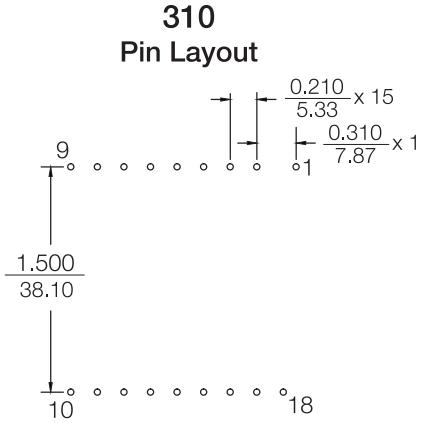
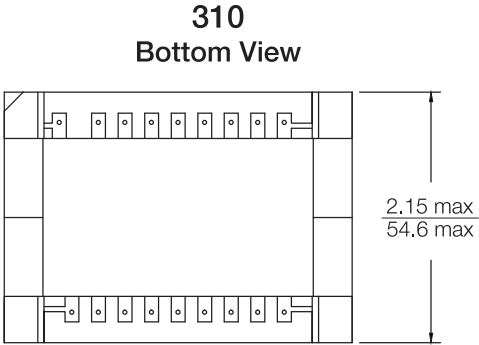
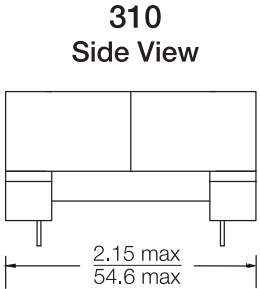
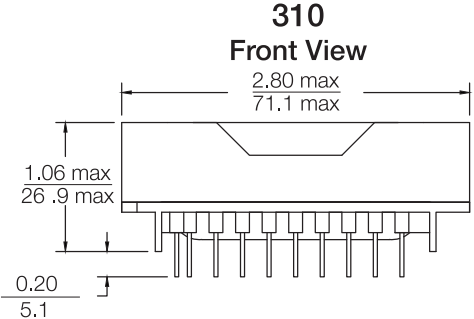

Tolerance:

Inches

- x.xx ± 0.010"
- x.xxx ± 0.005"

Millimeters

- x.x ± 0.25 mm
- x.xx ± 0.13 mm

