



west coast
magnetics

307 series

power inductors

PRODUCT DESCRIPTION

West Coast Magnetics' 307 series power inductors offer exceptional performance in a compact package. These inductors can handle very high DC currents and high AC ripple currents from 60 Hz up to 500 kHz. They offer exceptional reliability with an operating temperature rating of 200° C.

FEATURES & BENEFITS

Available with patented Foil Technology for high ripple, high frequency applications - Compact Size - Low Cost - High Current Rating - 200° C Temperature Rating

SHAPED FOIL TECHNOLOGY™

West Coast Magnetics' exclusive SHAPED FOIL TECHNOLOGY™ combines the low DCR of a foil winding, with the low AC winding resistance of litz wire. For many high ripple, high frequency applications it has significantly lower winding losses than any litz or solid wire winding. Check with WCM's engineering department to see if it is right for your application.

Product Code	Inductance (μH)	DCR (mOhms)	Current Rating* I _{rms} 40° C	Current Rating* I _{rms} 80° C	Current Rating* I _{rms} 120° C
307-1	193.4	14.72	20	28	34
307-2	154.8	11.29	22	32	39
307-3	128.7	9.01	25	36	44
307-4	90.5	6.04	31	44	54
307-5	64.8	4.06	38	53	66
307-6	59.0	3.62	40	57	70
307-7	48.3	2.94	44	63	77
307-8	43.4	2.58	47	67	82
307-9	30.1	1.84	55	79	97
307-10	26.2	1.51	62	88	108
307-11	19.3	1.15	70	101	124
307-12	16.2	0.95	78	111	136
307-13	13.4	0.75	88	125	152
307-14	10.8	0.65	95	134	165
307-15	8.6	0.50	108	152	188



*Current Rating:

The current values in this table are the approximate RMS current values which will lead to the temperature rise shown at the top of each column. The conditions under which the RMS current value in the table was determined are:

- 1) convective heat transfer with no outside cooling,
- 2) no core or AC winding losses, effectively a DC current is applied.

For ripple currents exceeding 2% additional margin must be allowed for core and AC copper losses.



power inductors

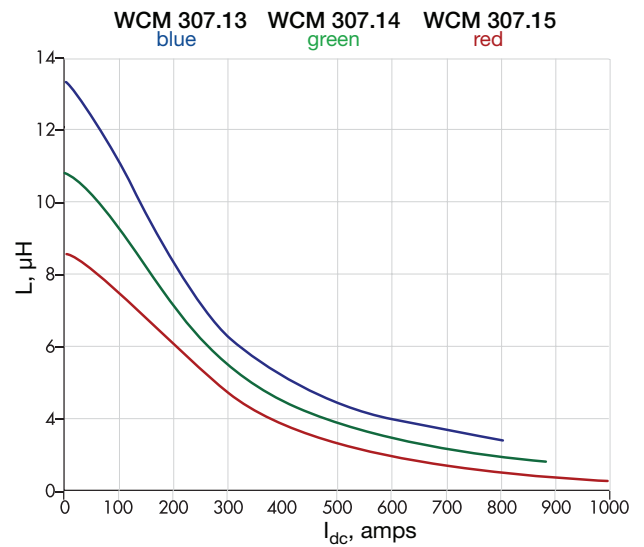
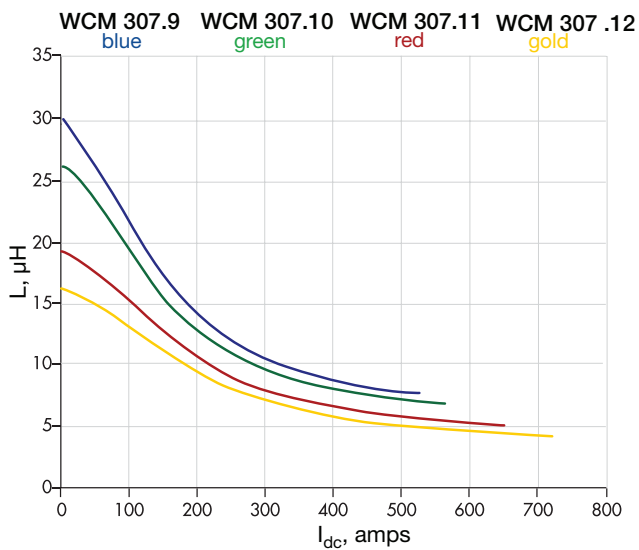
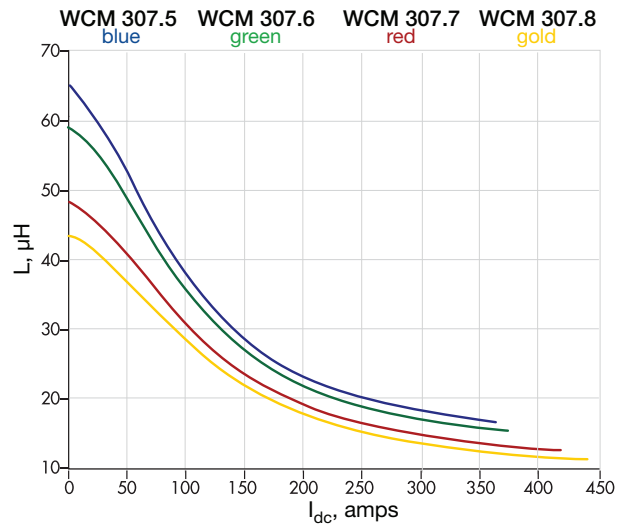
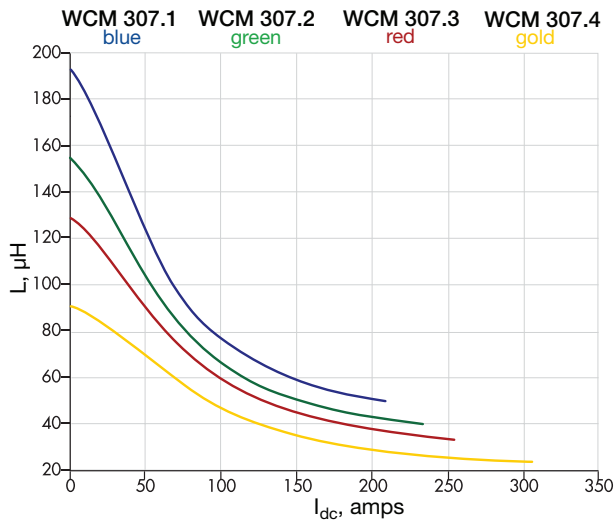

Dimensions: $\frac{\text{inches}}{\text{cm}}$

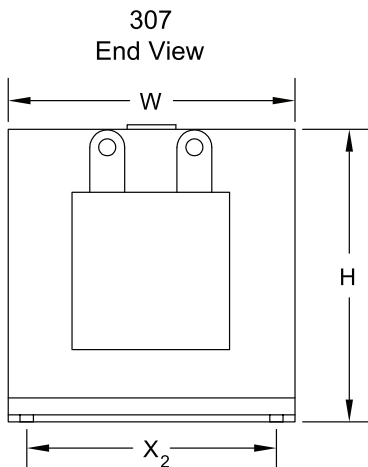
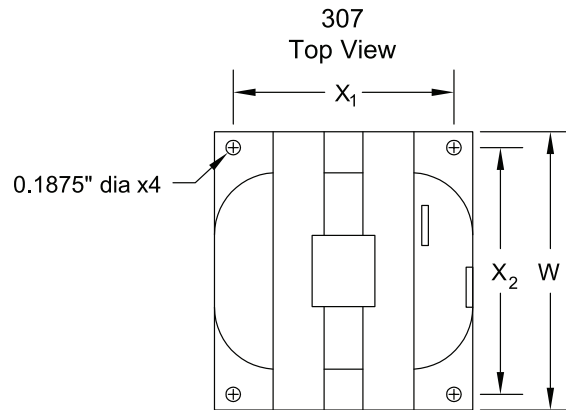
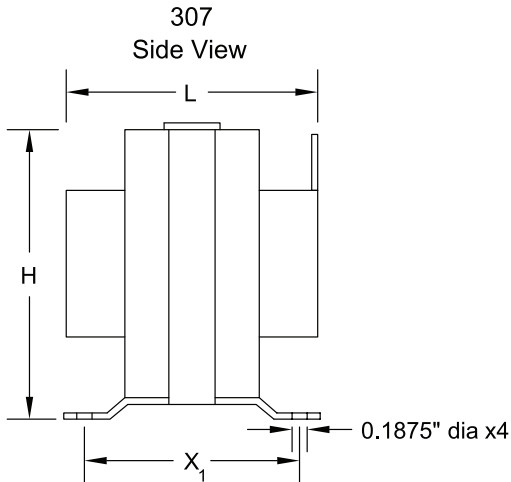

Product Code	W	H	L	X ₁	X ₂
307	$\frac{2.21}{5.61}$	$\frac{2.4}{6.10}$	$\frac{1.82}{4.57}$	$\frac{1.42}{3.61}$	$\frac{1.75}{4.45}$